

ITEM	DWG. NO.	NAME OF PARTS	SIZE	MATERIAL	UNIT	MASS	REMARKS

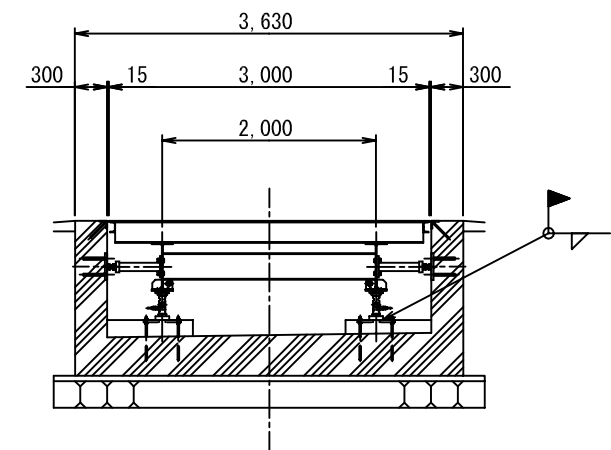
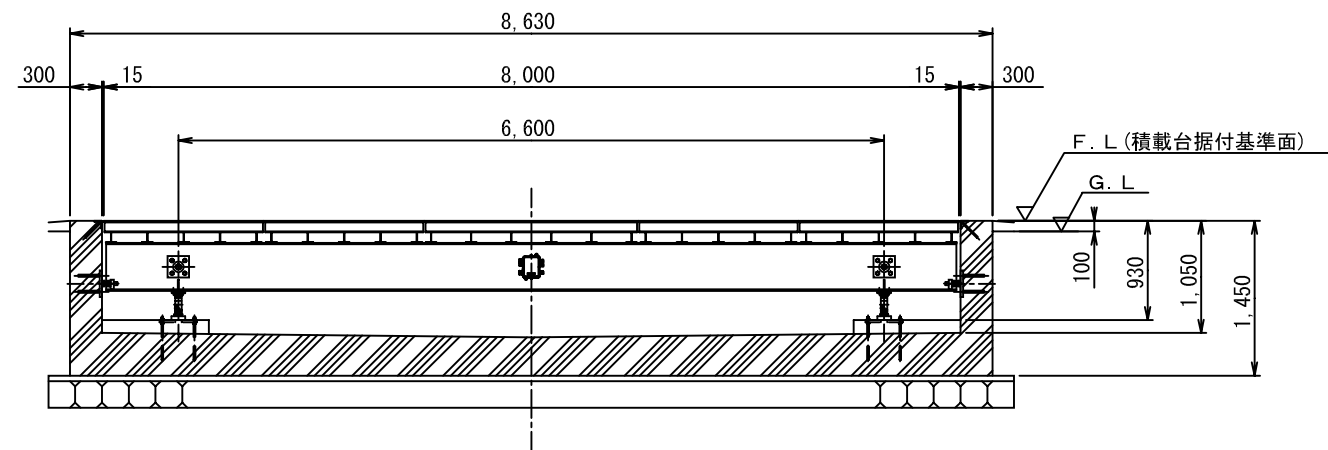
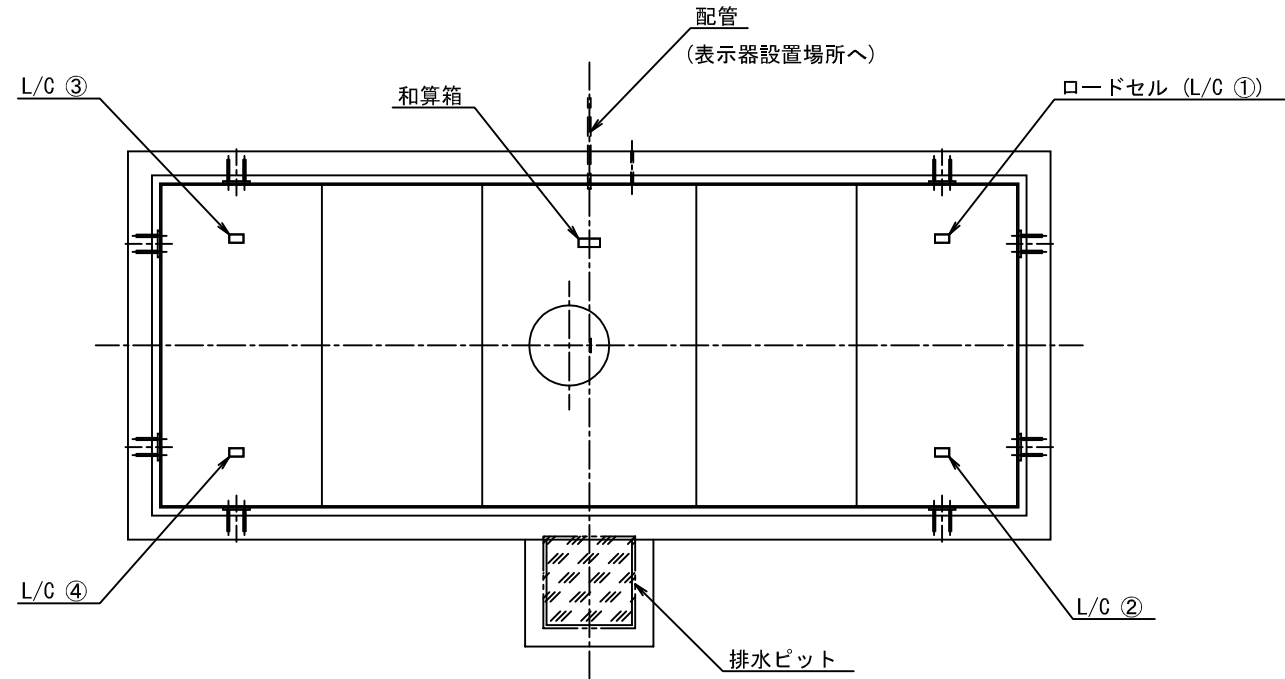

APPROVED	CHECKED	DESIGNED	DRAWN	TITLE
平川	河原	岩本	松浦	KMT 8-8030-1 トラックスケール
DATE '03.5.7				SCALE 1:50
ORIGINAL NO.				JFE Advantech Co., Ltd.
DRAWING NO.				DA 2-5527

MARK	REVISION	DATE	REVISED	APPROVED